



BAR 9.1 TRUE WIRELESS SURROUND WITH DOLBY ATMOS®



OWNER'S MANUAL

IMPORTANT SAFETY INSTRUCTIONS

Verify Line Voltage Before Use

The JBL Bar 9.1 True Wireless Surround with Dolby Atmos® (soundbar, detachable speakers and subwoofer) has been designed for use with 100-240 volt, 50/60 Hz AC current. Connection to a line voltage other than that for which your product is intended can create a safety and fire hazard and may damage the unit. If you have any questions about the voltage requirements for your specific model or about the line voltage in your area, contact your retailer or customer service representative before plugging the unit into a wall outlet.

Do Not Use Extension Cords

To avoid safety hazards, use only the power cord supplied with your unit. We do not recommend that extension cords be used with this product. As with all electrical devices, do not run power cords under rugs or carpets, or place heavy objects on them. Damaged power cords should be replaced immediately by an authorized service center with a cord that meets factory specifications.

Handle the AC Power Cord Gently

When disconnecting the power cord from an AC outlet, always pull the plug; never pull the cord. If you do not intend to use this speaker for any considerable length of time, disconnect the plug from the AC outlet.

Do Not Open the Cabinet

There are no user-serviceable components inside this product. Opening the cabinet may present a shock hazard, and any modification to the product will void your warranty. If water accidentally falls inside the unit, disconnect it from the AC power source immediately, and consult an authorized service center.

TABLE OF CONTENTS

IMPORTANT SAFETY INSTRUCTIONS 2

1. INTRODUCTION 4

2. WHAT'S IN THE BOX 4

3. PRODUCT OVERVIEW 5

- 3.1 SOUNDBAR 5
- 3.2 DETACHABLE SPEAKERS 6
- 3.3 SUBWOOFER 6
- 3.4 REMOTE CONTROL 6

4. PLACE 7

- 4.1 DESKTOP PLACEMENT 7
- 4.2 WALL-MOUNTING 7

5. CONNECT 9

- 5.1 CONNECTION WITH YOUR TV AND DIGITAL DEVICES 9
- 5.2 BLUETOOTH CONNECTION 11
- 5.3 CONNECTION WITH YOUR HOME NETWORK 11

6. SETUP 13

- 6.1 CONNECT THE DETACHABLE REAR SPEAKERS AND SUBWOOFER 13
- 6.2 CHARGE THE DETACHABLE SPEAKERS 13
- 6.3 SOUND CALIBRATION 14

7. PLAY 16

- 7.1 POWER-ON/AUTO STANDBY/AUTO WAKEUP/POWER-SAVING MODE 16
- 7.2 PLAY FROM THE TV SOURCE 17
- 7.3 PLAY FROM THE HDMI IN SOURCE 17
- 7.4 PLAY FROM THE BLUETOOTH SOURCE 18
- 7.5 PLAY THROUGH CHROMECAST BUILT-IN™ 18
- 7.6 PLAY THROUGH AIRPLAY 18
- 7.7 MULTI-ROOM PLAYBACK 19

8. SOUND SETTINGS 19

9. RESTORE FACTORY SETTINGS 20

10. SOFTWARE UPDATE 20

11. RE-CONNECT THE SUBWOOFER 21

12. PRODUCT SPECIFICATIONS 22

13. TROUBLESHOOTING 23

- SYSTEM 23
- SOUND 23
- BLUETOOTH 23
- WI-FI 23
- MUSIC STREAMING 23
- REMOTE CONTROL 23

14. TRADEMARKS 24

15. OPEN SOURCE LICENSE NOTICE 25

1. INTRODUCTION

Thank you for purchasing the JBL Bar 9.1 True Wireless Surround with Dolby Atmos® (soundbar, detachable speakers and subwoofer) which is designed to bring an extraordinary sound experience to your home entertainment system. We encourage you to take a few minutes to read through this manual, which describes the product and includes step-by-step instructions for setting up and getting started.

To make the most of product features and support, you may need to update the product software through the Internet and the USB connector in the future. Refer to the software update section in this manual to ensure that your product has the latest software.

Designs and specifications are subject to change without notice. If you have any questions about the soundbar, installation or operation, please contact your retailer or customer service representative, or visit our website: www.jbl.com.

2. WHAT'S IN THE BOX

Unpack the box carefully and ensure that the following parts are included. If any part is damaged or missing, do not use it and contact your retailer or customer service representative.

Soundbar



Subwoofer

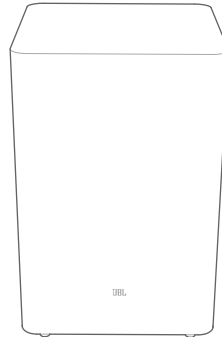

Detachable speakers

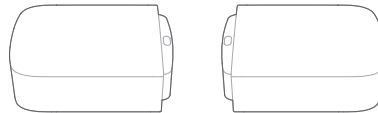

Remote control (with 2 AAA batteries)

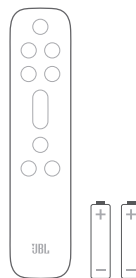

Power cord*

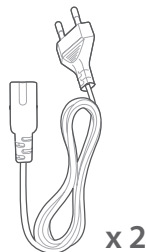

* Power cord quantity and plug type vary region.

HDMI cable

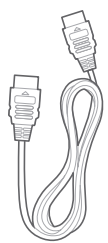

Wall-mounting kit

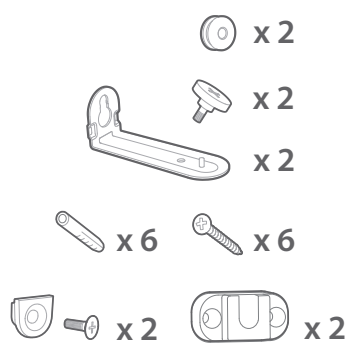

Product information & wall-mounting template



3. PRODUCT OVERVIEW

3.1 Soundbar

Controls

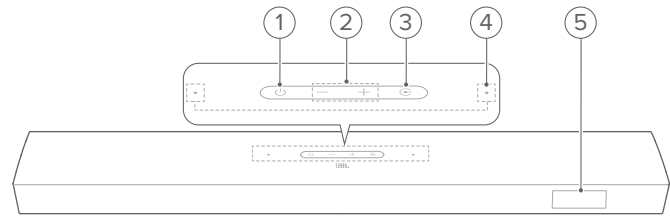

- 1) **⏻ (Power)**
 - Switch on or to standby
- 2) **-/+ (Volume)**
 - Decrease or increase the volume
 - Press and hold to decrease or increase the volume continuously
 - Press the two buttons together to mute or unmute
- 3) **⏮ (Source)**
 - Select a sound source: TV (default, for audio input from TV connection where the **HDMI OUT (TV ARC/ TV eARC)** connector is prioritized over the **OPTICAL** connector), Bluetooth or HDMI IN.
- 4) **🎤 (Microphone)**
 - For audio calibration (wireless surround sound) (For details, see “Sound calibration” in the “SETUP” chapter.)
- 5) **Status display**

Rear connectors

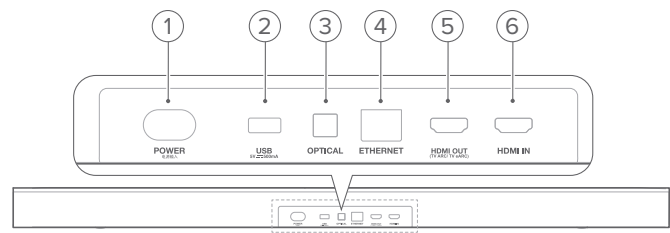

- 1) **POWER**
 - Connect to power (with the supplied power cord)
- 2) **USB**
 - USB connector for software update
 - Connect to a USB storage device for MP3 file playback (for US version only)
- 3) **OPTICAL**
 - Connect to the optical output on your TV or digital device

4) ETHERNET

- Connect to your home network through an Ethernet cable

5) HDMI OUT (TV ARC/ TV eARC)

- Connect to the HDMI ARC / HDMI eARC input on your TV

6) HDMI IN

- Connect to the HDMI output on your digital device

3.2 Detachable speakers

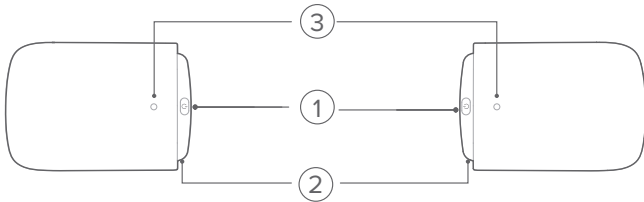

1) (Connect)

- Press to reconnect to the soundbar

2) Micro USB connector

- For battery charging

3) Status indicator

- For battery power

	Flashing red	Low battery (battery level: <20%)
	Solid red	Battery charging underway
	Off	Battery charging complete

- For wireless connection status

	Slow flashing white	Disconnected from the soundbar
	Fast flashing white	Connecting to the soundbar
	Solid white	Connected to the soundbar

3.3 Subwoofer

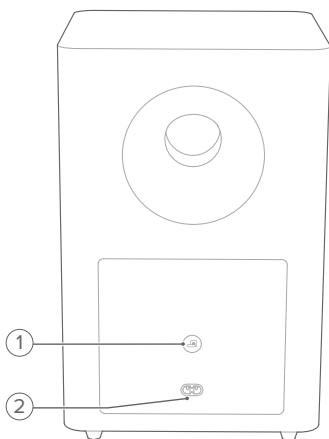

1)

- Connection status indicator





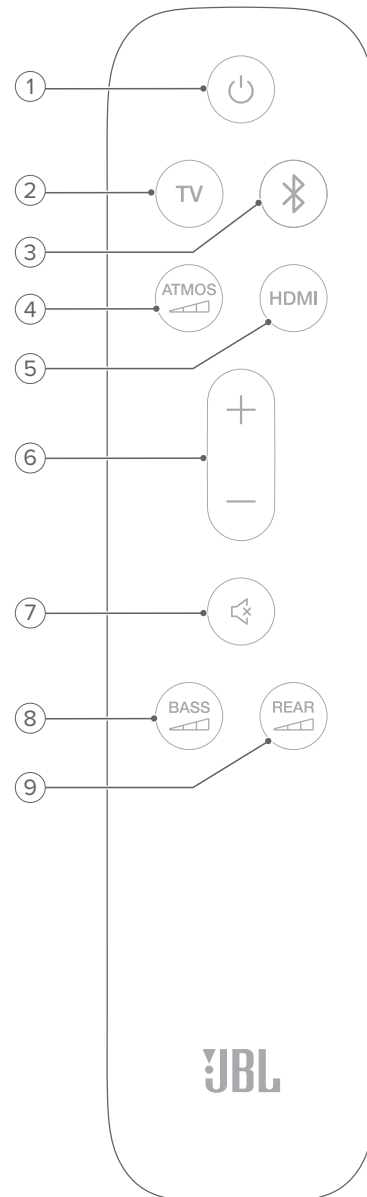

	Solid white	Connected to the soundbar
	Fast flashing white	Pairing mode
	Slow flashing white	Reconnecting or exiting the pairing mode
	Solid amber	Standby mode

2) POWER

- Connect to power (with the supplied power cord)

3.4 Remote control



- 1) 
 - Switch on or to standby
- 2) **TV**
 - Select the TV source (default, for audio input from TV connection where the **HDMI OUT (TV ARC/ TV eARC)** connector is prioritized over the **OPTICAL** connector)
- 3)  (**Bluetooth**)
 - Select the Bluetooth source
 - Press and hold to connect another Bluetooth device
- 4) **ATMOS** 
 - Select the level of Dolby Atmos/DTS:X effect: middle (default), high or low
- 5) **HDMI**
 - Select the **HDMI IN** source
 - Press and hold for more than 5 seconds to enter the calibration mode for wireless surround sound
- 6) **+ / -**
 - Increase or decrease the volume
 - Press and hold to increase or decrease the volume continuously.
- 7)  (**Mute**)
 - Mute/unmute
- 8) **BASS** 
 - Select the bass level for subwoofer: 1/2/3 (default)/4/5
- 9) **REAR** 

(available when both of the detachable rear speakers are undocked from the soundbar)

 - Select the surround sound level for rear speakers: middle (default), high, muted or low
 - Press and hold to mute/unmute the rear speakers

4. PLACE

4.1 Desktop placement

Place the soundbar, detachable speakers and subwoofer on a flat and stable surface. Refer to the recommended distance in the following diagram.

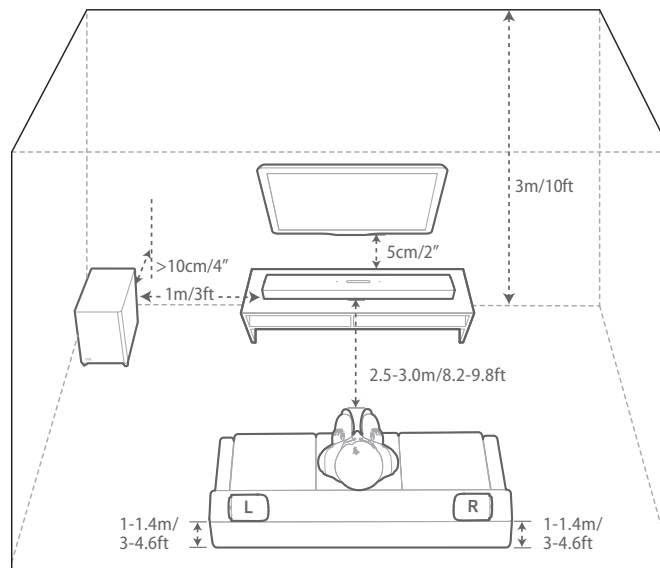

NOTES:

- The power cord shall be properly connected to power.
- Do not place any objects on the top of the soundbar, detachable speakers or subwoofer.
- Charge the detachable speakers in time to ensure sufficient battery power (See " Connect the detachable rear speakers" in the chapter "SETUP").

4.2 Wall-mounting

Wall-mount the soundbar and detachable rear speakers together or separately.

A) Wall-mount the soundbar

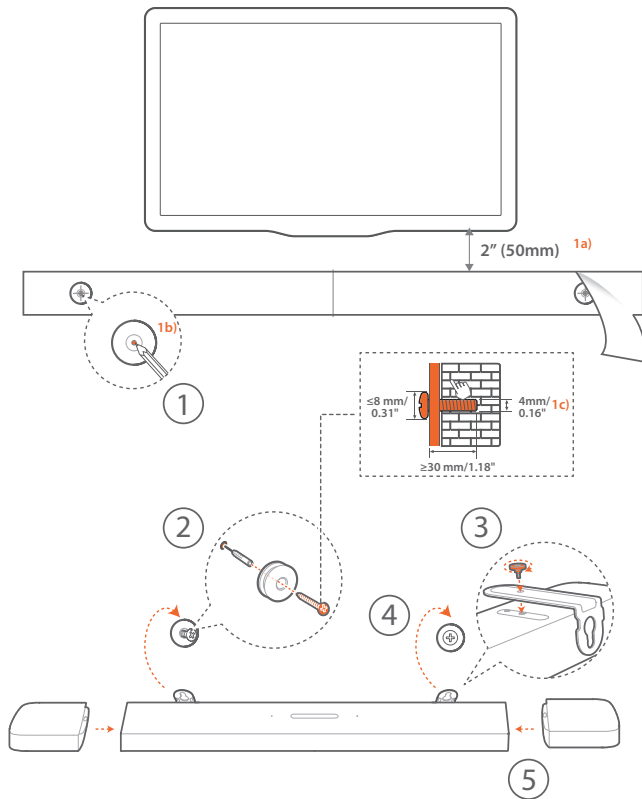

1. Preparation:

- a) With the distance of about 2" (50mm) from your TV, stick the supplied wall-mounting template to a wall by using adhesive tapes.
 - b) Use your ballpen tip to mark the screw holder location. Remove the template.
 - c) On the marked location, drill a 4 mm/0.16" hole.
2. Install the support for wall-mounting bracket.
 3. With the screw, fasten the wall-mounting bracket onto the bottom of the soundbar.
 4. Mount the soundbar.
 5. After the soundbar is securely wall-mounted, dock the two detachable speakers onto the soundbar.

NOTES:

- Make sure that the wall can support the weight of the soundbar.
- Install on a vertical wall only.
- Avoid a location under high temperature or humidity.
- Before wall-mounting, make sure that cables can be properly connected between the soundbar and external devices.
- Before wall-mounting, make sure that the soundbar is unplugged from power. Otherwise, it may cause an electric shock.
- To move the soundbar, first remove the two detachable speakers to avoid accidental damage.

B) Wall-mount the detachable speakers as rear surround speakers

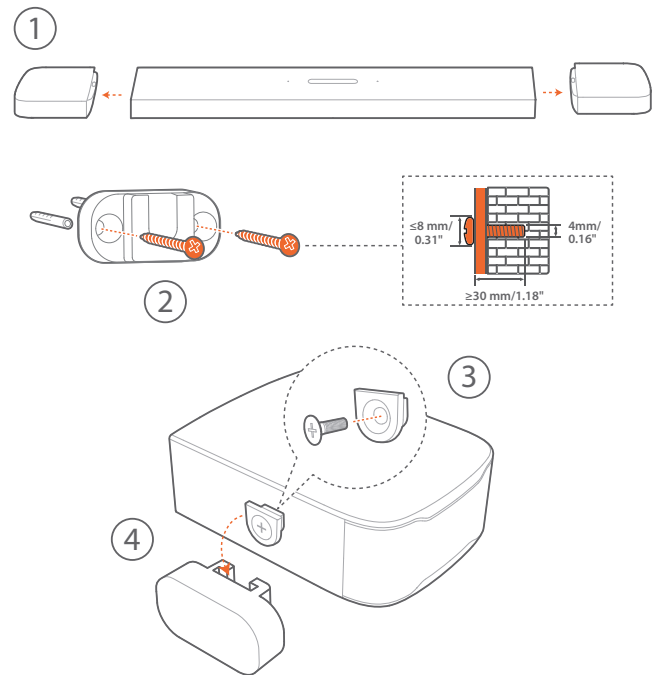

1. From the soundbar, remove the two detachable speakers.
2. Install the wall-mounting bracket.
3. Fasten the support onto the back of the speakers.
4. Mount the speakers.

5. CONNECT

5.1 Connection with your TV and digital devices

For audio playback through the soundbar, connect the soundbar with your TV through the supplied HDMI cable or an optical cable (sold separately).

An HDMI connection supports digital audio and video with a single connection. HDMI connectivity is the best option for your soundbar.

TV (HDMI ARC / eARC)

(Recommended connection for the best Dolby Atmos / DTS:X experience)

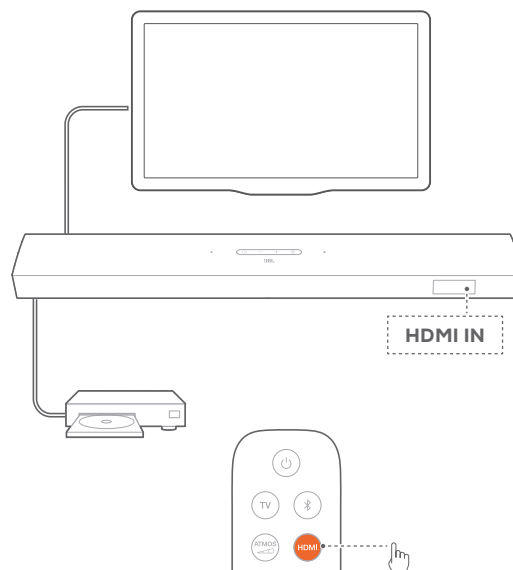
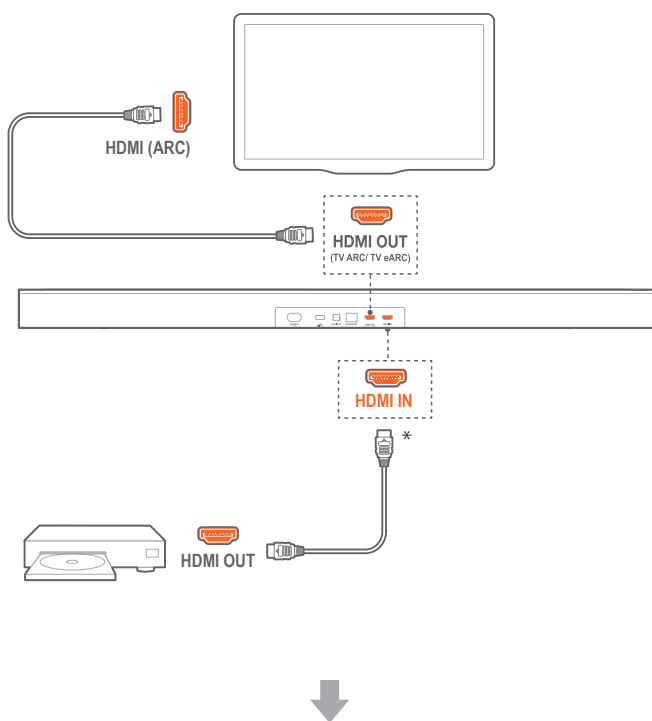

1. Connect the soundbar with the **HDMI IN (ARC / eARC)** connector on your TV by using the supplied HDMI cable.
 - On your TV, check that HDMI-CEC and HDMI ARC / eARC have been enabled. Refer to the owner's manual of your TV for more information.
2. Use an HDMI cable (V2.0 or later) to connect the soundbar with your digital device, such as a set-top box, DVD/Blu-ray player or game console.
 - On your digital device, check that HDMI-CEC has been enabled. Refer to the owner's manual of your digital device for more information.
 - On your digital device, select "Bitstream" or "Raw data" in the audio output settings for the best Dolby Atmos experience.
3. To play audio from the digital device connected to the soundbar, select **HDMI** on the remote control.

TV (HDMI eARC)

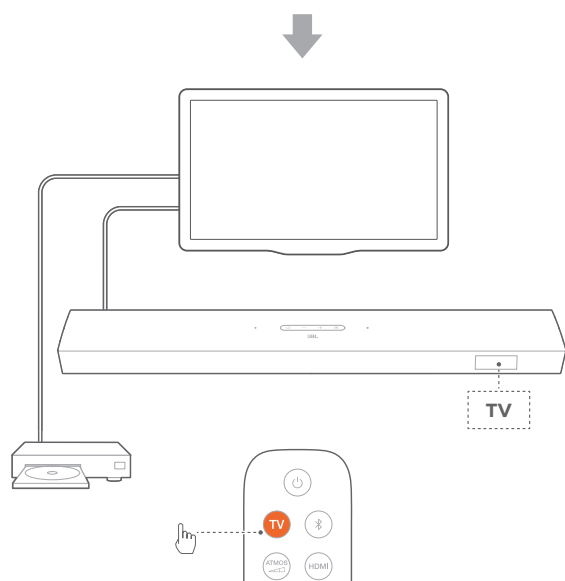
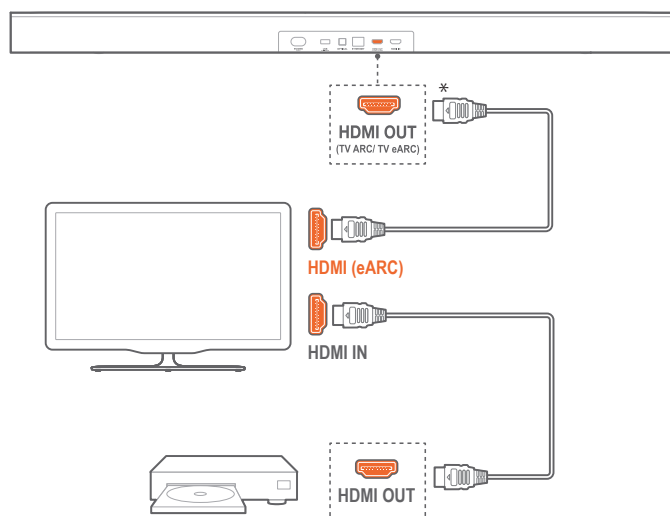

1. Connect the soundbar with the **HDMI IN (eARC)** connector on your TV by using the supplied HDMI cable.
 - On your TV, check that HDMI-CEC and HDMI ARC / eARC have been enabled. Refer to the owner's manual of your TV for more information.
2. Use an HDMI cable (eARC compatible, V2.0 or later) to connect your TV with your digital device, such as a streaming device, set-top box, DVD/Blu-ray player or game console.
 - On your digital device, check that HDMI-CEC has been enabled. Refer to the owner's manual of your digital device for more information.
 - On your TV and digital device, select "Bitstream" or "Raw data" in the audio output settings for the best Dolby Atmos experience.
3. To play audio from the digital device connected to your TV, select **TV** on the remote control.

OPTICAL

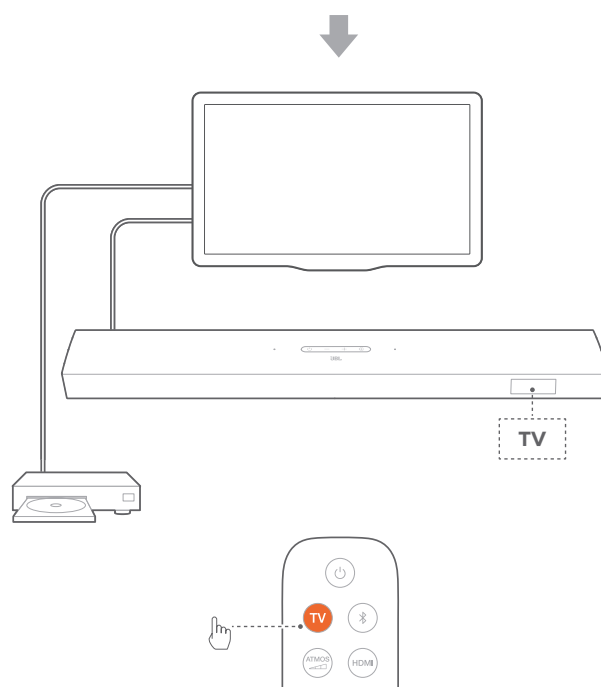
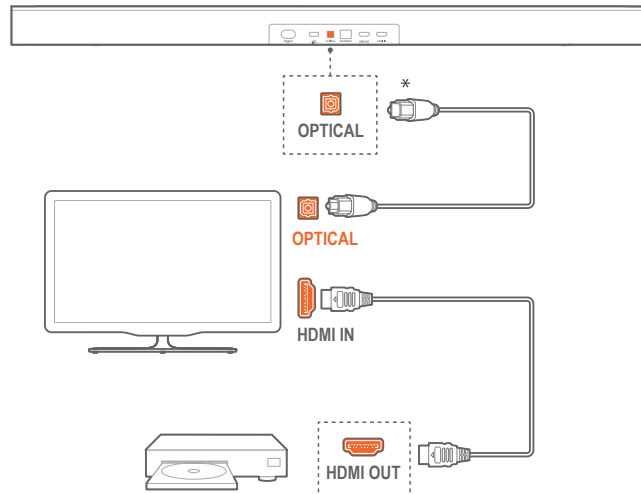

NOTES:

- With the 4 up-firing speakers and the detachable surround speaker design, the Dolby surround upmixer of the soundbar can expand the legacy channel-based audio of Dolby Digital format, including 5.1 and 7.1 content, and provide an immersive 3D Atmos experience.

1. Connect the soundbar with your TV by using an optical cable.
2. Use an HDMI cable (V2.0 or later) to connect your TV with your digital device, such as a streaming device, set-top box, DVD/Blu-ray player or game console.
3. To play audio through the optical cable, select **TV** on the remote control.

NOTES:

- * The HDMI cable (for digital device connection) and the optical cable are sold separately.
- Full compatibility with all HDMI-CEC devices is not guaranteed.
- When both HDMI ARC and optical cables are connected to the soundbar for audio input from TV connection, the HDMI ARC connection is prioritized.

5.2 Bluetooth connection

Through Bluetooth, connect the soundbar with your Bluetooth device, such as a smartphone, tablet and laptop.

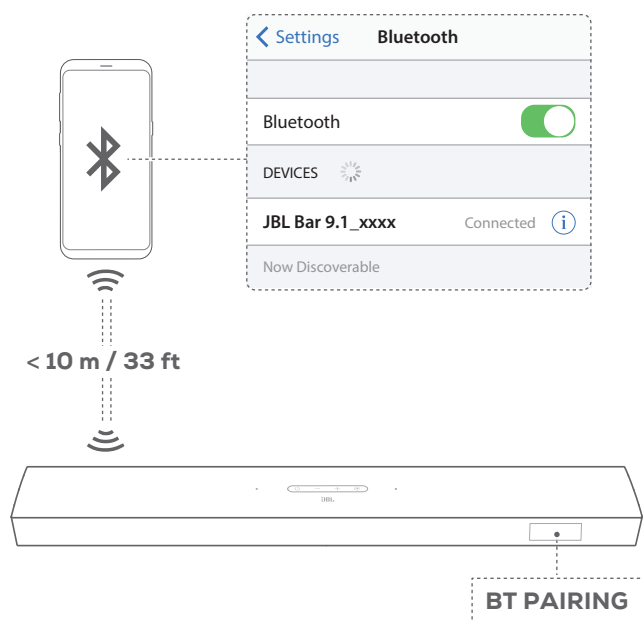

Connect a Bluetooth device

1. Press **⏻** to switch on (See “Power-on/Auto standby/Auto wakeup” in the “PLAY” chapter).
2. To select Bluetooth source, press **Ⓞ** on the soundbar or **🔗** on the remote control.
 - **“BT PAIRING”**: Ready for BT pairing
3. On your Bluetooth device, enable Bluetooth and search for **“JBL Bar 9.1_xxxx”** within three minutes.
 - **Successful connection**: The device name is displayed if your device is named in English. A confirmation tone is heard.

To reconnect the last paired device

Your Bluetooth device is retained as a paired device when the soundbar goes to standby mode. Next time you switch to the Bluetooth source, the soundbar reconnects the last paired device automatically.

To connect to another Bluetooth device

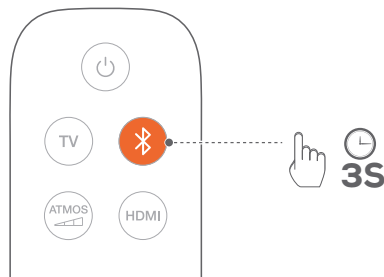

1. In the Bluetooth source, press and hold **Ⓞ** on the soundbar or **🔗** on the remote control until **“BT PAIRING”** is displayed.
 - The previously paired device is cleared from the soundbar.
 - The soundbar enters the Bluetooth pairing mode.
2. Follow the Step 3 under “Connect a Bluetooth device”.
 - If the device has ever been paired with the soundbar, first unpair **“JBL Bar 9.1_xxxx”** on the device.

NOTES:

- The Bluetooth connection will be lost if the distance between the soundbar and Bluetooth device exceeds 33 ft (10 m).
- Electronic devices may cause radio interference. Devices that generate electromagnetic waves must be kept away from the Soundbar, such as microwaves and wireless LAN devices.

5.3 Connection with your home network

Through Wi-Fi or an Ethernet cable, connect the soundbar to your home network. With Chromecast built-in and AirPlay supported, the soundbar allows you to stream audio on smartphones or tablets through the soundbar speakers.

1. On the soundbar, enter the Wi-Fi setup mode:
 - Press **⏻** to switch on (See “Power-on/Auto standby/Auto wakeup/Power-saving mode” in the “PLAY” chapter).
 - If the soundbar has not been connected to a network, the screen shows **“HELLO”** and then, **“SETUP WIFI”**.
 - To re-enter the Wi-Fi setup mode, press and hold **⏻** until **“RESET WIFI”** is displayed.

- On your Android or iOS device, add the soundbar to your home Wi-Fi network.

Through the Google Home app

- Connect your Android or iOS device to your home Wi-Fi network. Download the Google Home app. Sign in with your Google account. If you do not have, create a new one.
- Follow the app instructions to complete setup.

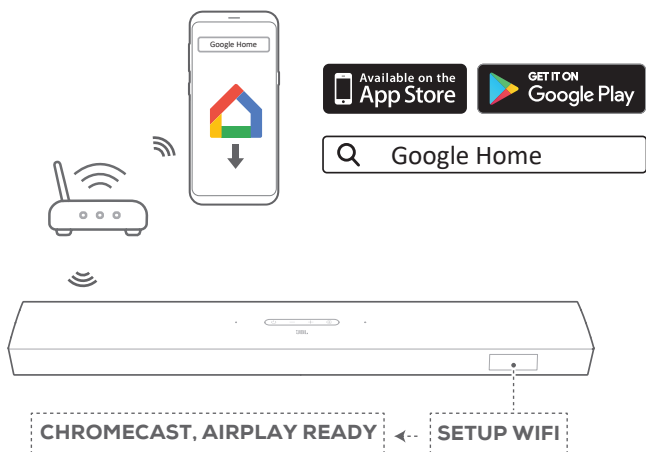

*Through AirPlay setup on an iOS device

- Connect your iOS device to your home Wi-Fi network.
- On your iOS device, go to **Settings** > **Wi-Fi**. Under **SET UP NEW AIRPLAY SPEAKER...**, select **"JBL Bar 9.1_xxxx"** and follow onscreen instructions to complete setup.

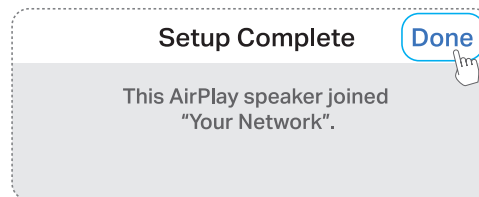
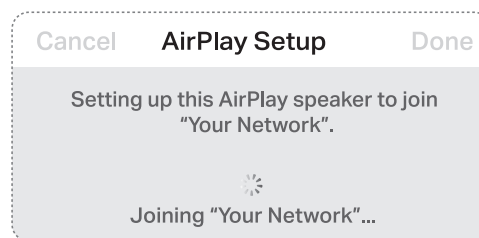
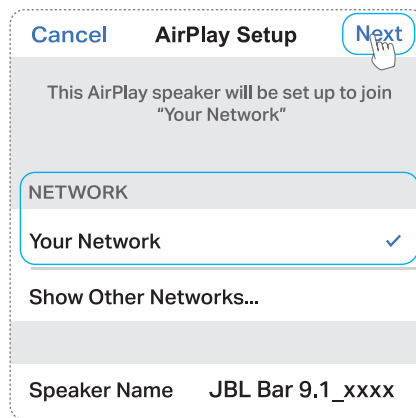
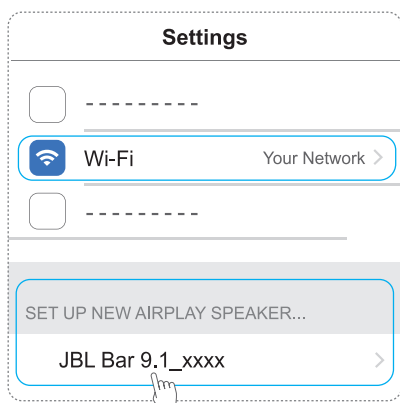

- If necessary, use an Ethernet cable to connect the soundbar to your home network.
 - Make sure that you connect to the same network as you did during the setup.

NOTES:

- During the Wi-Fi setup through the Google Home app, you can name the soundbar and organize it by room.
- On your iOS device, add the soundbar to the Apple Home app and manage it together with other AirPlay 2-compatible speakers.
- *On your iOS device, if the soundbar has been added to your home Wi-Fi network through the Google Home app, skip the steps under "Through AirPlay setup on an iOS device" and you can start AirPlay streaming from an AirPlay-compatible app (See "Play through AirPlay" in the "PLAY" chapter).

6. SETUP

6.1 Connect the detachable rear speakers and subwoofer

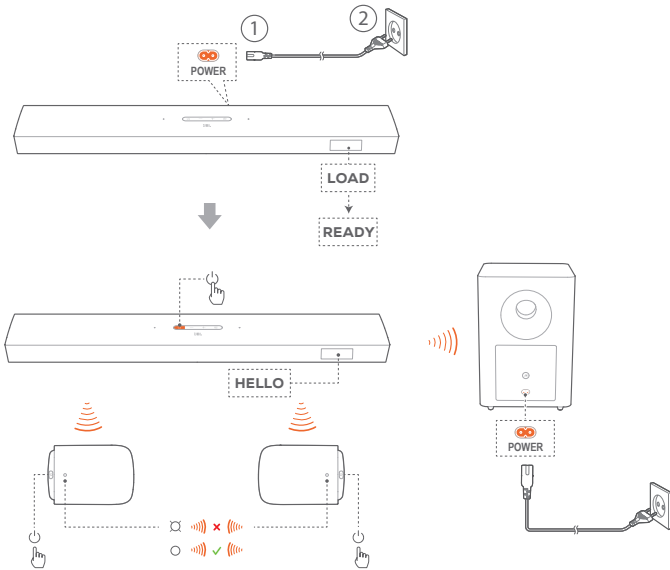

1. Connect the soundbar to power by using the supplied power cord.
 - The screen on the soundbar shows “LOAD” and then, “READY”.
2. Do the following to start the connection:
 - Connect the subwoofer to power by using the supplied power cords;
 - On the soundbar, press \odot to switch on;
 - Dock the detachable speakers onto the soundbar, or press \odot on the detachable speakers to fast re-connect to the soundbar.
 - The soundbar connects the subwoofer automatically. **Connected:** \odot turns solid white on the subwoofer.
 - The soundbar connects the detachable speakers automatically. **Connected:** The status indicator turns solid white (\odot) on the detachable speakers.

6.2 Charge the detachable speakers

Wi-Fi and Bluetooth connection will be off and the soundbar will enter into power saving mode when the detachable surround speakers are out of battery.

The first time you use the two detachable speakers, charge them for more than 3 hours to ensure sufficient battery power.

- When the battery power runs low, the status indicator flashes red on the detachable surround speakers and “CHARGE SPKR. BATT LOW” is displayed on the soundbar.
- When the battery power runs out, “DOCK SPKR” or “DETECTING SPKR” is displayed on the soundbar.

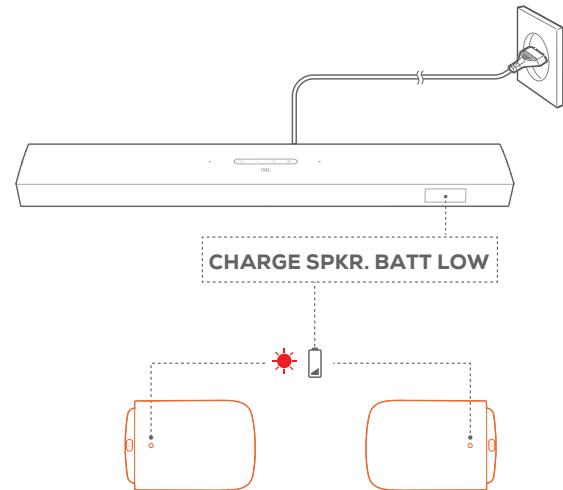

6.2.1 Charge by docking the detachable speakers

With the detachable speakers docked, the soundbar will enter the charging mode after switching to standby mode.

- **STDBY:** The detachable speakers are fully charged (\bullet turns off). The soundbar returns to standby mode.
- The charging mode exits when the soundbar is switched on (after auto wake-up or by your pressing \odot on the soundbar or remote control). See “Power-on/Auto-standby/Auto wake-up/Power-saving mode” in the “PLAY” chapter.
- It takes about 3 hours for the empty battery to be fully charged.

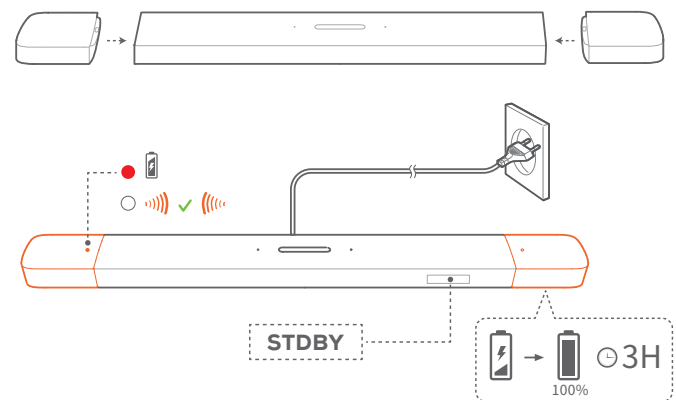

6.2.2 Charge through a USB cable

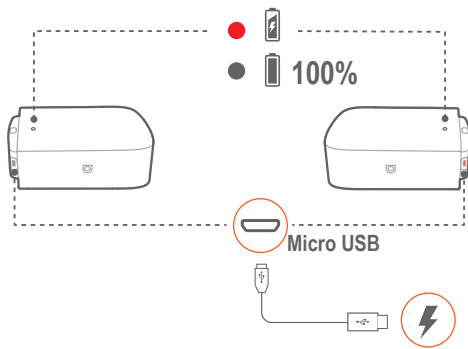

- Use a USB cable to connect the detachable speakers to power respectively.
- For the detachable speakers, the status indicator is used for status indication of both battery power and wireless connection (See “Detachable speakers” in the “PRODUCT OVERVIEW” chapter).

NOTES:

- * The USB cable is sold separately.

6.3 Sound calibration

For sound calibration, do the following:

- Make sure that your room is quiet;
- Make sure that the soundbar and the two detachable rear speakers are fully in sight of each other, without obstacles in between.
- Make sure that the left and right rear speakers are properly placed, the **L** speaker on the left and the **R** speaker on the right.

6.3.1 Wireless surround sound

With the audio calibration, your surround sound experience will be optimized for your favorite seating and speaker positions.

1) Calibrate the listening zone

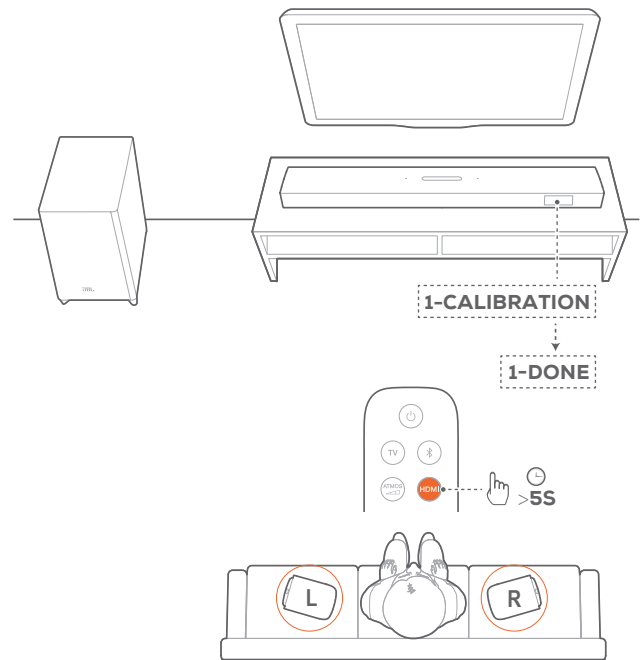

1. Place the detachable rear speakers beside your seating position.
 - Make sure that the two detachable speakers have been connected to the soundbar (See “Wireless connection” under “Connect the detachable rear speakers” in the “SETUP” chapter).
2. On the remote control, press and hold **HDMI** until “**1-CALIBRATION**” is displayed on the soundbar.
 - Countdown starts from 5 to 1.
 - Calibration tone is heard. Audio calibration starts.
 - “**CALIBRATING**”: Calibration ongoing.
 - “**1-DONE**”: Calibration of the listening zone is completed successfully.

2) Calibrate the speaker position

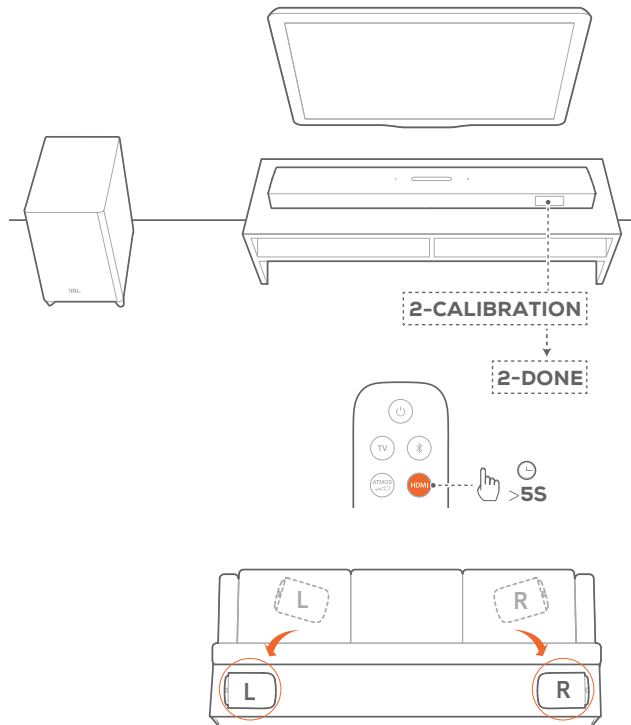

1. Place the detachable rear speakers in your desired location.
2. On the remote control, press and hold **HDMI** until **"2 -CALIBRATION"** is displayed on the soundbar.
 - Countdown starts from 5 to 1.
 - Calibration tone is heard. Audio calibration starts.
 - **"CALIBRATING"**: Calibration ongoing.
 - **"2-DONE"**: Calibration of the speaker position is completed successfully.
3. To select suitable surround sound, press **REAR** repeatedly to switch between high, low or middle (default).

NOTES:

- During calibration, all buttons on the remote control are disabled except for **⏻** and **HDMI**.
- **"SETUP FAILED"** is displayed if calibration failed.

6.3.2 Dolby Atmos® / DTS:X®

With Dolby Atmos or DTS:X, overhead audio distribution is provided for powerful 3D sound immersion.

1. To play the surround sound of DOLBY ATMOS or DTS:X, connect and play your Blu-ray player or streaming device as described under "Connection with your TV and digital devices" in the "CONNECT" chapter.
2. To select suitable strength for Dolby Atmos or DTS:X, press **ATMOS** on remote control to switch between middle (default), high, low or off.

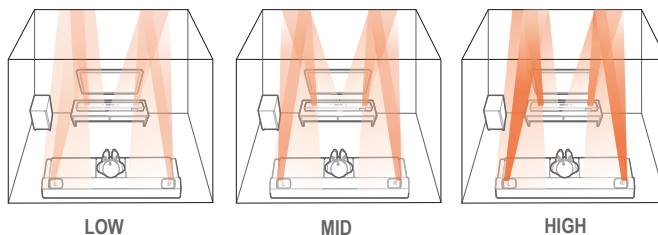

7. PLAY

7.1 Power-on/Auto standby/Auto wakeup/ Power-saving mode

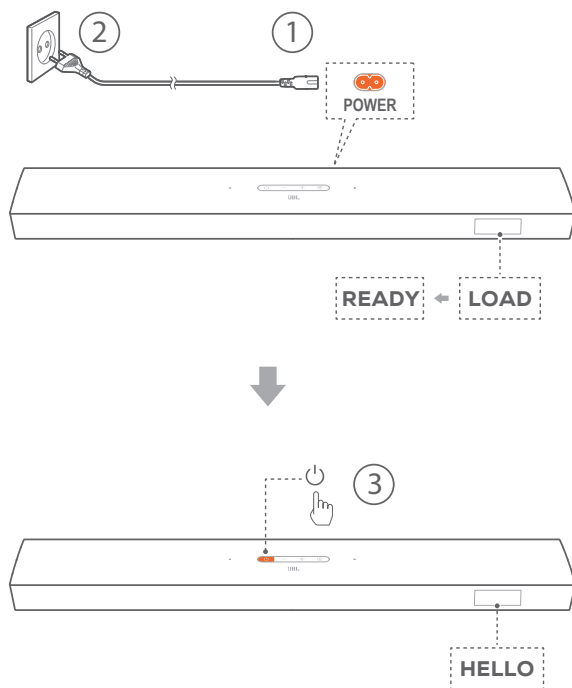

Switch on

- On the soundbar, press \odot to switch on.
 - “HELLO” is displayed.
 - The subwoofer is reconnected to the soundbar automatically. **Connected:**  turns solid white.
 - On the detachable speakers, press \odot to reconnect to the soundbar.

Auto standby

If the soundbar is inactive for more than 10 minutes, it will switch to standby mode automatically. “STDBY” is displayed.

- The subwoofer also goes to standby, and  turns solid amber.
- 10 minutes later, the detachable speakers switches to standby, and the status indicator turns off for wireless connection status.
- Next time you switch on the soundbar, it returns to the last selected source.

Auto wakeup

In standby mode, the soundbar will wake up automatically when

- the soundbar is connected to your TV through the HDMI ARC connection and your TV is switched on;
- the soundbar is connected to your TV through an optical cable and audio signals are detected from the optical cable;

- the soundbar is connected to your TV through the HDMI ARC connection and through the HDMI connection, is also connected to your digital device such as a set-top box, DVD/Blu-ray player or game console, and your digital device is switched on;
- the soundbar is connected to your home network and audio is streamed to the soundbar through Chromecast built-in or AirPlay.

Power-saving mode

In power-saving mode, Wi-Fi and Bluetooth are disabled on the soundbar. You cannot wake up the soundbar by playing music through Chromecast built-in or AirPlay.

The soundbar will switch to standby, and then enter power-saving mode if the detachable speakers

- run out of power; or
- lose wireless connection.

On the detachable speakers, the status indicator flashes red; on the soundbar, “DOCK SPKR” or “DETECTING SPKR” is displayed. Charge the detachable speakers by docking them onto the soundbar or through USB cables (See “Charge the detachable speakers” in the “SETUP” chapter). If necessary, press \odot on the detachable speakers to re-connect to the soundbar.

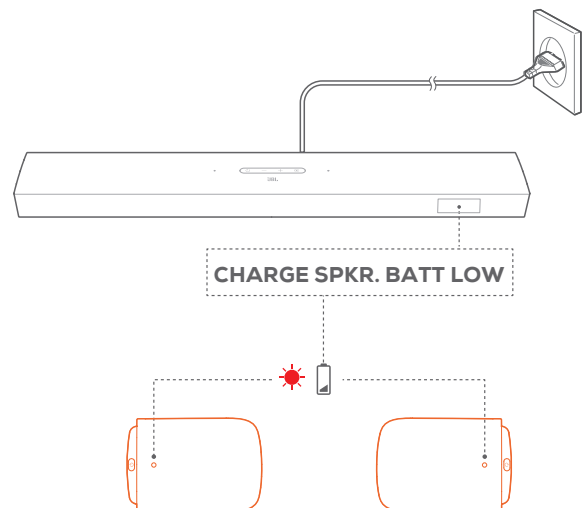

7.2 Play from the TV source

With the soundbar connected, you can enjoy TV audio from the soundbar speakers.

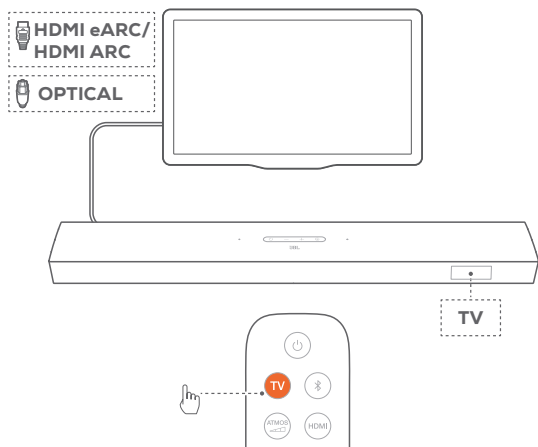

1. Make sure that your TV is set to support external speakers and the built-in TV speakers are muted. Refer to the owner's manual of your TV for more information.
2. Make sure that the soundbar has been properly connected to your TV (See "Connection with your TV and digital devices" in the "CONNECT" chapter).
3. To select the TV source, press **G** on the soundbar or **TV** on the remote control.
 - "TV": The TV source is selected.
 - In the factory settings, the TV source is selected by default.

NOTES:

- If the soundbar is connected to your TV through both an HDMI cable and an optical cable, the HDMI cable source is selected for the TV connection.

7.2.1 TV remote control setup

To use your TV remote control for both your TV and the soundbar, check that your TV supports HDMI-CEC. If your TV does not support HDMI-CEC, follow the steps under "TV remote control learning".

HDMI-CEC

If your TV supports HDMI-CEC, enable the functions as instructed in your TV user manual. You can control the volume +/-, mute/unmute, and power on/standby functions on your soundbar through the TV remote control.

TV remote control learning

1. On the soundbar, press and hold **G** and **+** until "LEARNING" is displayed.
 - You enter the TV remote control learning mode.
2. Within 15 seconds, do the following on the soundbar and your TV remote control:
 - a) On the soundbar: press one of the following buttons **+**, **-**, **+** and **-** together (for the mute/unmute function), and **U**.
 - b) On your TV remote control: press the desired button.

- "WAIT" is displayed on the soundbar.
 - "DONE": The function of the soundbar button is learnt by your TV remote control button.
3. Repeat Step 2 to complete the button learning.
 4. To exit the TV remote control learning mode, press and hold **G** and **+** on the soundbar until "EXIT LEARNING" is displayed.
 - The soundbar returns to the last selected source.

7.3 Play from the HDMI IN source

With the soundbar connected as shown, your digital device can play video on your TV and audio from the soundbar speakers.

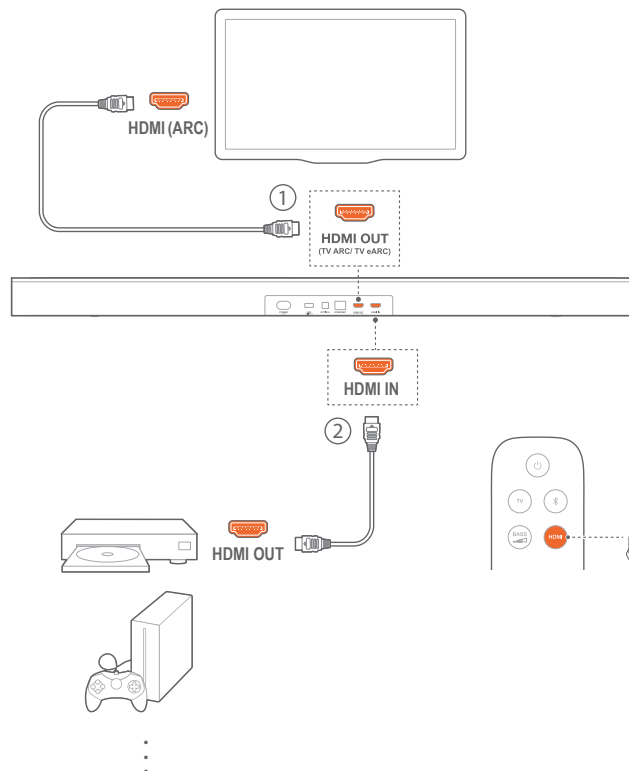

1. Make sure that the soundbar has been properly connected to your TV and digital device (See "Connection with your TV and digital devices" in the "CONNECT" chapter).
2. Switch on your digital device.
 - Your TV and the soundbar wake up from standby mode and switch to the input source automatically.
 - To select the **HDMI IN** source on the soundbar, press **G** on the soundbar or **HDMI** on the remote control.
3. Switch your TV to standby mode.
 - The soundbar and source device are switched to standby mode.

NOTES:

- Full compatibility with all HDMI-CEC devices is not guaranteed.

7.4 Play from the Bluetooth source

Through Bluetooth, stream audio play on your Bluetooth device to the soundbar.

1. Check that the soundbar has been properly connected to your Bluetooth device (See “Bluetooth connection” in the “CONNECT” chapter).
2. To select the Bluetooth source, press **G** on the soundbar or **⌘** on the remote control.
3. Start audio play on your Bluetooth device.
4. Adjust the volume on the soundbar or your Bluetooth device.

7.5 Play through Chromecast built-in™

Through Chromecast built-in, stream audio on your Android or iOS device to the soundbar.

1. On the soundbar,
 - a) Check that the soundbar has been properly connected to your home network (See “Connection with your home network” in the “CONNECT” chapter).
 - b) Check that the soundbar has been switched on or to standby mode.
2. On your Android or iOS device,
 - a) Check that your Android or iOS device has been connected to the same network as the soundbar.
 - b) On a Chromecast-enabled app, play music, tap the cast icon  and select the connected soundbar.



3. To exit from the music playback, switch to other sources.

7.6 Play through AirPlay

Through AirPlay, stream audio on your iOS device to the soundbar.

1. On the soundbar,
 - Check that the soundbar has been properly connected to your home network (See “Connection with your home network” in the “CONNECT” chapter).
2. On your iOS device,
 - a) Check that your iOS device has been connected to the same network as the soundbar.
 - b) To enter the Control Center on an iOS device, swipe down from the upper right corner (iOS 12 or later) or swipe up from the bottom edge (iOS 11 or earlier). Tap  to select the connected soundbar and then, start audio streaming from an app.



3. To exit from the music playback, switch to other sources.

NOTES:

- The soundbar can support audio streaming and cannot support video streaming.
- During streaming through Chromecast built-in or AirPlay, music playback pauses on the current connected device when you start music playback on a second connected device.
- When the soundbar switches between your home Wi-Fi and wired network during AirPlay 2, music playback pauses and will resume in a few minutes, depending on the bandwidth condition of broadband. For the connection to your home wired network, see Step 3 under “Connection with your home network” in the Chapter “CONNECT”.

7.7 Multi-room playback

With the multi-room playback, you can stream music on your Android or iOS device to multiple Chromecast-enabled/ AirPlay speakers.

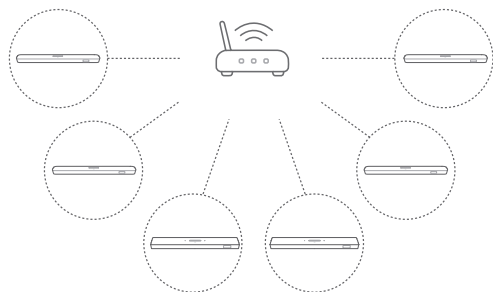

Chromecast built-in

1. Through the Google Home app, connect multiple Chromecast-enabled speakers to the same network, assign them to multiple rooms, and create groups as needed.
2. Run a Chromecast-enabled app on your smartphone or tablet.
3. Play music. Press  and select the grouped speakers.

NOTES:

- Refer to the Google Home app for more details.
- Depending on the bandwidth of your local network, you can stream music to up to 6 Chromecast-enabled speakers.

AirPlay

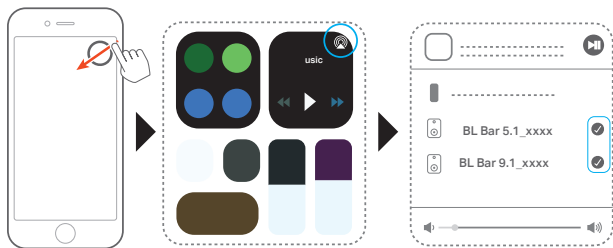

1. On an iOS device, enter the Control Center.
2. Tap  to select multiple connected speakers as needed.
3. Start music streaming from an app.

8. SOUND SETTINGS

Bass adjustment

1. Check that the soundbar and subwoofer are properly connected (See the “SETUP” chapter).
2. On the remote control, press  repeatedly to switch between bass levels.
→ “LVL1” to “LVL5” is displayed (default: “LVL3”).

Rear adjustment

With both of the detachable rear speakers undocked, you can select the surround sound level.

1. Check that the soundbar and the detachable rear speakers are connected wirelessly (See the “SETUP” chapter).
2. On the remote control, press  repeatedly to switch between surround sound levels.
→ “MID” / “HIGH” / “MUTED REAR SPKR” / “LOW” is displayed (default: “MID”).
→ “NOT SUPPORTED” is displayed if the detachable rear speakers have been docked onto the soundbar.

To mute or unmute the undocked rear speakers,

- press and hold 
→ “MUTED REAR SPKR” is displayed.
→ When unmuted, the rear speakers return to the last selected surround sound level.

Audio sync

With the audio sync function, you can synchronize audio and video to make sure that no delay is heard from your video content.

1. On the remote control, press and hold **TV** for more than three seconds and then, press +.
2. Within five seconds, press + or - on the remote control to adjust the audio delay and match with video.
→ The audio sync timing is displayed.

NOTES:

- If no action is taken within five seconds, you will exit the audio sync mode.

Smart mode

With the smart mode enabled by default, you can enjoy TV programs with rich sound effects. For TV programs such as news and weather forecasts, you can reduce sound effects by disabling the smart mode and switching to the standard mode.

Smart mode: EQ settings and JBL Surround Sound are applied for rich sound effects.

Standard mode: The preset EQ settings are applied for standard sound effects.

To disable the smart mode, do the following:

1. On the remote control, press and hold  for more than three seconds. Press +.
→ Current mode is displayed. “ON SMART MODE”: The smart mode is enabled.
2. Repeat Step 1.

- You switch to another mode. **"OFF SMART MODE"**: The standard mode is enabled.
- Next time you switch on the soundbar, the smart mode is enabled again automatically.

9. RESTORE FACTORY SETTINGS

By restoring the default settings defined at factories, you remove all your personalized settings from the soundbar.

- On the soundbar, press and hold **⏻** and **↺** for more than 10 seconds.
 - **"RESET"** is displayed.
 - The soundbar shows **"LOAD"** and **"READY"** and then, goes to standby mode.

10. SOFTWARE UPDATE

For optimal product performance and your best user experience, JBL may offer software updates for the soundbar system in the future. Please visit www.jbl.com or contact JBL call center to receive more information about downloading update files.

Updating online



- On the soundbar, mount the two detachable speakers when "UPDATE FOUND" is displayed.
 - "UPDATING": Software updating underway
 - "DONE": Software updating completed

NOTES:

- For automatic online upgrading when update software is available, make sure that the two detachable speakers have been docked onto the soundbar.

Updating through a USB storage device

1. Check that you have saved the software update file to the root directory of a USB storage device.
2. Check that you have docked the detachable speakers onto the soundbar. Connect the USB device.

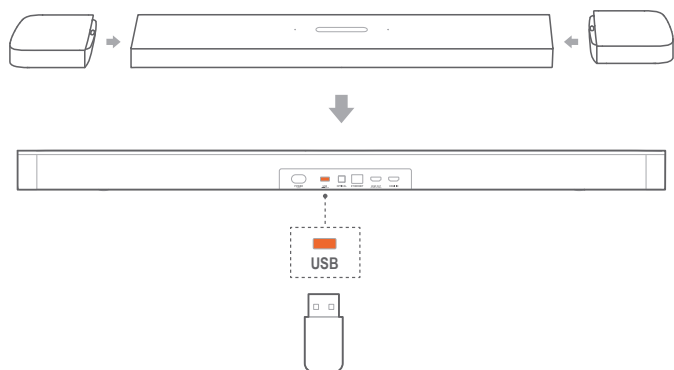

3. To enter the software update mode, press and hold \cup and - on the soundbar for more than 10 seconds.
 - "UPDATE MODE" is displayed.
 - "WAIT": Software updating underway
 - "DONE": Software updating completed
 - The soundbar returns to the last selected source.

NOTES:

- Keep the soundbar powered on and the USB storage device mounted before software updating is complete.
- "UPDATE FOUND DOCK SPKR" is displayed if the two detachable speakers are not properly mounted onto the soundbar.
- "PLUG IN USB" is displayed if no USB storage device is detected, and 5 minutes later, the soundbar exits the software update mode.
- "Error" is displayed if software updating has failed twice.

11. RE-CONNECT THE SUBWOOFER

The soundbar and subwoofer are paired at factories. After power-on, they are paired and connected automatically. In some special cases, you may need to pair them again.

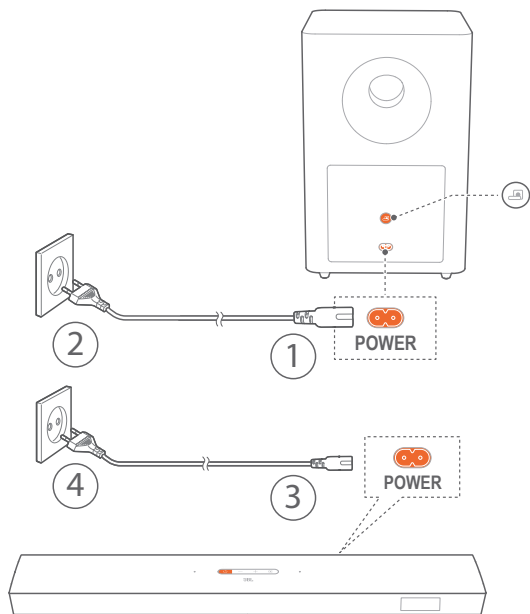

To re-enter the subwoofer pairing mode

1. On the rear panel of subwoofer, press and hold  until it turns fast flashing white.
2. To enter the subwoofer pairing mode on the soundbar, press and hold **BASS** on the remote control for more than five seconds. Press - on the remote control.
 - **"PAIRING"**: The subwoofer is ready for pairing.
 - **"CONNECTED"**: The subwoofer is connected.

NOTES:

- The subwoofer will exit the pairing mode in three minutes if pairing and connection are not completed.  turns from fast flashing white to slow flashing white.

12. PRODUCT SPECIFICATIONS

General specification:

- Model: BAR 9.1 CNTR (soundbar unit), BAR 9.1 SURROUND (detachable speaker), BAR 9.1 SUB (subwoofer unit)
- Sound system: 5.1.4 channel
- Power supply: 100 - 240V AC, ~ 50/60 Hz
- Lithium battery: 3.635 V, 3283 mAh
- Total speaker power output (Max. @THD 1%): 820 W
- Soundbar output power (Max. @THD 1%): 400 W
- Surround speaker output power (Max. @THD 1%): 2 x 60 W
- Subwoofer output power (Max. @THD 1%): 300 W
- Soundbar transducer: 4 x racetrack drivers + 2 x up-firing full-range drivers + 3 x 0.75" (20 mm) tweeter
- Surround transducer (per piece): up-firing full-range drivers + 0.75" (20 mm) tweeter
- Subwoofer transducer: 10"
- Operating temperature: 0°C - 45 °C

HDMI specification:

- HDMI Video input: 1
- HDMI Video output (with enhanced Audio Return Channel, eARC): 1
- HDMI HDCP version: 2.3

Audio specification:

- Frequency response: 34 Hz - 20 KHz
- Audio inputs: 1 Optical, Bluetooth, USB (USB playback is available in US version. For other versions, USB is for service only.)

USB specification (Audio playback is for US version only):

- USB port: Type A
- USB rating: 5 V = 500 mA
- Supporting file format: MP3
- MP3 Codec: MPEG 1 Layer 2/3, MPEG 2 Layer 3, MPEG 2.5 Layer 3
- MP3 sampling rate: 16 KHz - 48 KHz
- MP3 bitrate: 80 kbps - 320 kbps

Wireless specification:

- Bluetooth version: 4.2
- Bluetooth profile: A2DP V1.2, AVRCP V1.5
- Bluetooth frequency range: 2402 MHz - 2480 MHz
- Bluetooth Max. transmitting power: < 13 dBm (EIRP)
- Modulation Type: GFSK, π/4 DQPSK, 8DPSK
- Wi-Fi network: IEEE 802.11 a/b/g/n/ac (2.4GHz/5GHz)
- 2.4G Wi-Fi frequency range: 2412 - 2472 MHz (2.4GHz ISM Band, USA 11 Channels, Europe and others 13 Channels)
- 2.4G Wi-Fi Max. transmitting power: 20 dBm (EIRP)
- Modulation Type: DBPSK, DQPSK, CCK, QPSK, BPSK, 16QAM, 64QAM

- 5G Wi-Fi frequency range: 5.15 - 5.35 GHz, 5.470-5.725 GHz, 5.725 - 5.825 GHz
- 5G Wi-Fi Max. transmitting power: 22 dBm (EIRP)
- Modulation Type: QPSK, BPSK, 16QAM, 64QAM, 256QAM
- 5G wireless frequency range: 5180.0 - 5240.0 MHz, 5725.0 - 5825.0 MHz (varies depending on country, if applicable)
- 5G Max. transmitting power: 13 dBm (EIRP)
- Modulation Type: QPSK

Dimensions

- Dimensions (W x H x D):
884 x 62 x 120mm / 34.8 x 2.4 x 4.7 inches (soundbar);
173 x 60 x 120 mm / 6.8 x 2.4 x 4.7 inches (detachable surround speaker, per piece);
305 x 440 x 305mm / 12.0 x 17.3 x 12.0 inches (subwoofer)
- Weight:
3.64 kg / 8.0 lb (soundbar);
0.72 kg x 2 / 1.6 lb x2 (detachable surround speaker);
11.10 kg / 24.5 lb (subwoofer)

13. TROUBLESHOOTING

Never try to repair the product yourself. If you have problems using this product, check the following points before you request services.

System

The unit will not turn on.



- Check if the power cord is plugged into power and the soundbar.

The soundbar has no response to button pressing.

- Restore the soundbar to factory settings (See the "RESTORE FACTORY SETTINGS" chapter).

Sound

No sound from soundbar

- Make sure that the soundbar is not muted.
- Select the correct audio input source on the remote control.
- Connect the soundbar to your TV or other devices properly
- Restore the soundbar to its factory settings by pressing and holding  and  on the soundbar for more than 10 seconds.

Distorted sound or echo

- If you play audio from your TV through the soundbar, make sure that your TV is muted or the built-in TV speaker is disabled.

Audio and video are not synchronized.

- Enable the audio sync function to synchronize audio and video (See "Audio sync" in the "SOUND SETTINGS" chapter).

Bluetooth

A device cannot be connected with the soundbar.

- Check if you have enabled Bluetooth on the device.
- If the soundbar has been paired with another Bluetooth device, reset Bluetooth (see "To connect to another device" under "Bluetooth connection" in the "CONNECT" chapter).
- If your Bluetooth device has ever been paired with the soundbar, reset Bluetooth on the soundbar, unpair the soundbar on the Bluetooth device, and then, pair the Bluetooth device with the soundbar again (see "To connect to another device" under "Bluetooth connection" in the "CONNECT" chapter).

Poor audio quality from a connected Bluetooth device

- The Bluetooth reception is poor. Move the source device closer to the soundbar, or remove any obstacle between the source device and the soundbar.

The connected Bluetooth device connects and disconnects constantly.

- The Bluetooth reception is poor. Move the source device closer to the soundbar, or remove any obstacle between the source device and the soundbar.

Wi-Fi

Failed to connect to Wi-Fi.

- Make sure that Wi-Fi is turned on.
- Make sure that you have selected the right network and entered the correct password.
- Make sure that your router or modem is turned on and within the range.
- Make sure that your soundbar is connected to the same wireless LAN as your smartphone or tablet.
- On the soundbar that you have connected to Wi-Fi through the AirPlay speaker setup on an iOS device, make sure that you connect the soundbar to the same Wi-Fi network when you set up Chromecast built-in through the Google Home app.

The Google Home app cannot find the device.

- Make sure that your soundbar is powered on.
- Make sure that your network is working properly.
- Make sure that your router or modem is powered on and within the range.

Music streaming

Failed to stream music from Chromecast built-in or AirPlay

- Wi-Fi and Bluetooth connection will be off and the soundbar will enter into power saving mode when the detachable surround speakers are out of battery. Charge the two detachable speakers in time to ensure sufficient battery power. (See “Charge the detachable speakers” in the “SETUP” chapter).

Remote control

The remote control does not work.

- Check if the batteries are drained. If so, replace them with new ones.
- Reduce the distance and angle between the remote control and the main unit.

14. TRADEMARKS



The Bluetooth® word mark and logos are registered trademarks owned by Bluetooth SIG, Inc. and any use of such marks by HARMAN International Industries, Incorporated is under license. Other trademarks and trade names are those of their respective owners.



The terms HDMI, HDMI High-Definition Multimedia Interface, and the HDMI Logo are trademarks or registered trademarks of HDMI Licensing Administrator, Inc.



The Wi-Fi CERTIFIED™ Logo is a certification mark of the Wi-Fi Alliance®.



Manufactured under license from Dolby Laboratories. Dolby, Dolby Atmos, Dolby Audio, Dolby Vision and the double-D symbol are trademarks of Dolby Laboratories.



The Chromecast built-in logo is a trademark of Google LLC.



For DTS patents, see <http://patents.dts.com>. Manufactured under license from DTS, Inc. DTS, the Symbol, DTS and the Symbol together, DTS:X, and the DTS:X logo are registered trademarks or trademarks of DTS, Inc. in the United States and/or other countries. © DTS, Inc. All Rights Reserved.



Apple®, AirPlay®, iPad®, iPad Air®, iPad Pro® and iPhone® are trademarks of Apple Inc., registered in the U.S. and other countries. Use of the Works with Apple badge means that an accessory has been designed to work specifically with the technology identified in the badge and has been certified by the developer to meet Apple performance standards.

To control this AirPlay 2-enabled speaker, iOS 11.4 or later is required.

15. OPEN SOURCE LICENSE NOTICE

This product contains open source software licensed under GPL. For your convenience, the source code and relevant build instruction are also available at https://harman-webpages.s3.amazonaws.com/jbl_9.1_3D_Surround_package_license_list.htm. Please feel free to contact us at:

Harman Deutschland GmbH

HATT: Open Source, Gregor Krapf-Gunther,
Parking 3 85748 Garching bei Munchen, Germany

or OpenSourceSupport@Harman.com if you have additional question regarding the open source software in the product.



HARMAN International Industries,
Incorporated 8500 Balboa
Boulevard, Northridge, CA 91329
USA
www.jbl.com

© 2020 HARMAN International Industries, Incorporated.
All rights reserved.

JBL is a trademark of HARMAN International Industries, Incorporated, registered in the United States and/or other countries. Features, specifications and appearance are subject to change without notice.